

Section 1 – Installation Preparation

Part Number: PTR03-35160

NOTE: Part number of this accessory may not be the same as the part number shown.

Kit Contents

Item #	Qty.	Service Part #	Description
1	1	PTR03-34140	TRD Panel Air Filter
2	1	PTR03-35160-AA	Upper Airbox
3	1	PTR03-35160-AB	Intake Tube
	1	PTR03-35160-AC	Throttle Body Coupler Kit
4	1	341032	Coupler
5	1		#52 Hose Clamp
6	1		#48 Hose Clamp
	1	PTR03-35160-AD	Airbox Bellows Kit
7	1	341033	Bellows
5	2		#52 Hose Clamp
8	1	PTR03-35160-AE	Intake Flow Accelerator

Additional Items Required For Installation

Item #	Quantity Req'd.	Description
None		

Conflicts

NA

Recommended Tools

Safety Tools	Notes
Vehicle Protection	Blankets or Fender Covers
Special Tools	Notes
None Required	
Installation Tools	Notes
Nut Driver or Socket	8mm or 5/16"
Nut Driver or Socket	10mm & 12mm
Drive Ratchet	
Drive Extension	
Needle Nose Pliers	
Torque Wrench	In.lb. (0-120 in.lb.)
Phillips Screw Driver	#3
Special Chemicals	Notes
None	

General Applicability

Tacoma: 3.5L V-6 2016 →

Torque Specifications

Hardware Type	SAE Torque in.lb	Metric Torque Nm
Hose Clamp	30 ±5.0	3.4 ±0.6

Please see Page 15 for important “Care and Maintenance” information!

Vehicle Service Parts (may be required for reassembly)

Item #	Quantity Req'd.	Description

Legend

 **STOP:** Damage to the vehicle may occur. Do not proceed until process has been complied with.

 **OPERATOR SAFETY:** Use caution to avoid risk of injury.

 **CAUTION:** A process that must be carefully observed in order to reduce the risk of damage to the accessory/vehicle and to ensure a quality installation.

 **TOOLS & EQUIPMENT:** Used in Figures calls out the specific tools and equipment recommended for this process.

 **REVISION MARK:** This mark highlights a change in installation with respect to previous issue.

 **SAFETY TORQUE:** This mark indicates that torque is related to safety.

Emissions Compliance Information:

A new process has been implemented. The Emissions Label is No Longer included in the Performance Air Intake Kit.

If your state requires an Emissions Compliance Label, one may be ordered through your Toyota dealer or the Toyota Materials Distribution Center (MDC) 310-468-9800 or MDC@toyota.com

This TRD Performance Air Intake Kit has received 50-State Emissions Compliance via the California Air Resources Board (CARB). Not all states require the Emissions Compliance Label but TRD does recommend ordering one. To receive the proper Emissions Compliance Label for this TRD Performance Air Intake Kit, please order **MDC Part Number 00602-50001**. Proof of ownership may be required.

Section 1 – Installation Preparation

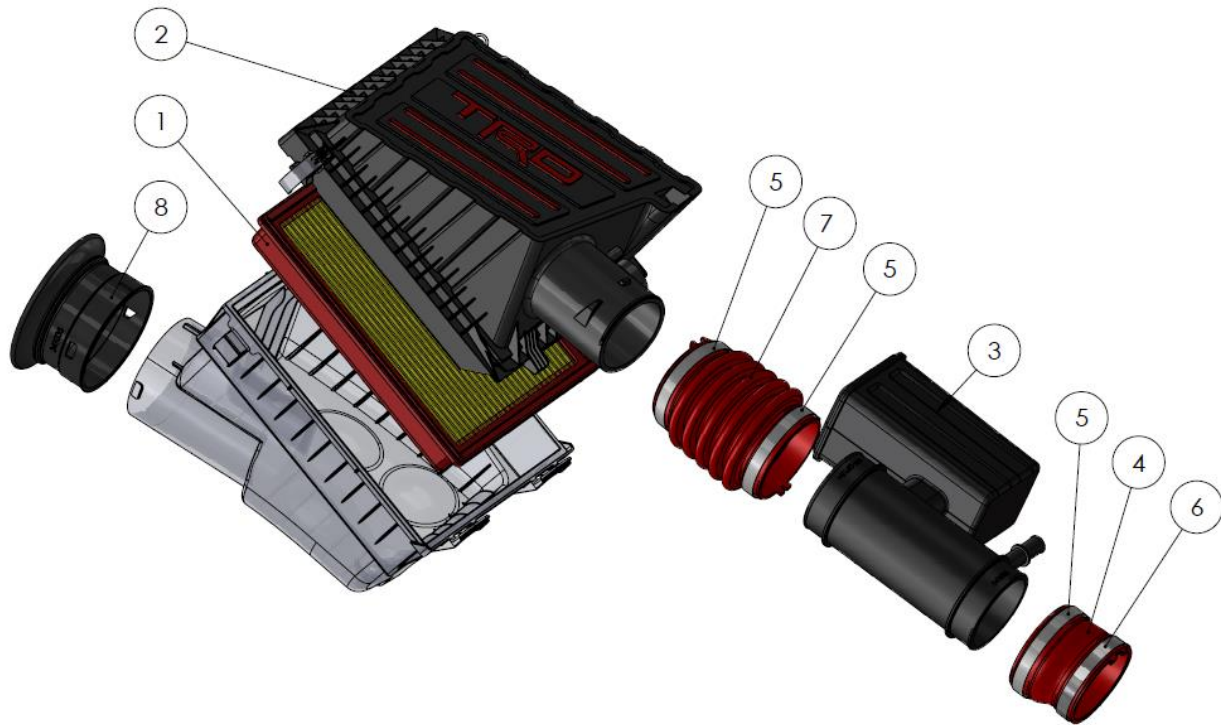

Section 1 – Installation Preparation

Care must be taken when installing this accessory to ensure damage does not occur to the vehicle. The installation of this accessory should follow approved guidelines to ensure a quality installation.

These guidelines can be found in the "Accessory Installation Practices" document.



This document covers such items as:-

- Vehicle Protection (use of covers and blankets, cleaning chemicals, etc.).
- Safety (eye protection, rechecking torque procedure, etc.).
- Vehicle Disassembly/Reassembly (panel removal, part storage, etc.).
- Electrical Component Disassembly/Reassembly (battery disconnection, connector removal, etc.).

Please see your Toyota dealer for a copy of this document.



1. Vehicle and Parts Preparation

- (a) Check kit for contents and damage.
- (b) Completely familiarize yourself with the beginning. (Fig. 1-1)
 - 1. OEM Air Box
 - 2. Air Box Inlet Tube
 - 3. Engine Cover
-  (c) Apply vehicle protection to prevent damage to painted surfaces.
- (d) Prior to installation, make sure all parts of the Performance Air Intake are clean and free of debris.
-  (e) Loosen the M6 bolt securing the negative terminal to the battery and remove the terminal. (Fig. 1-2)

Section 2 – Removal

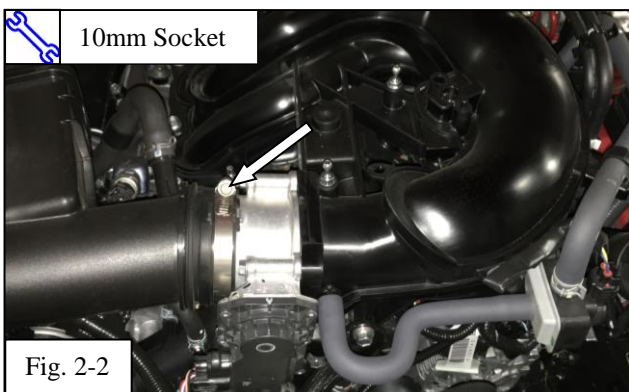
**2. Remove Factory Components**

- (a) In the vehicle, lift up on the front of the engine cover and pull forward to remove. (Fig. 2-1)

- (b) Loosen the inlet tube hose clamp at the throttle body. (Fig. 2-2)

- (c) Squeeze the clamp on the PCV hose, slide it back and disconnect the hose from the inlet duct. (Fig. 2-3)

Section 2 – Removal



(d) Squeeze the clip and unplug the MAFS harness. (Fig. 2-4)

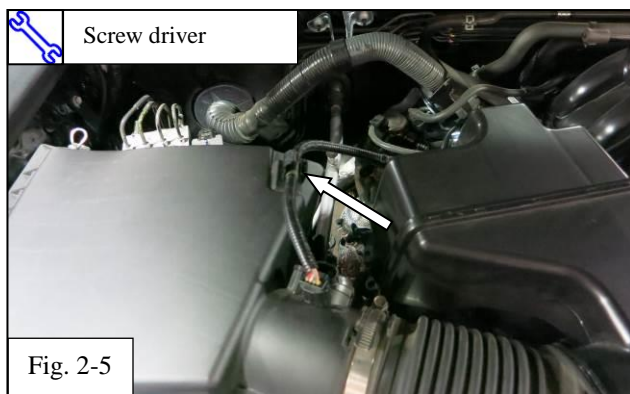

(e) Unclip the MAFS wiring harness from the top of the factory airbox lid. (Fig. 2-5)

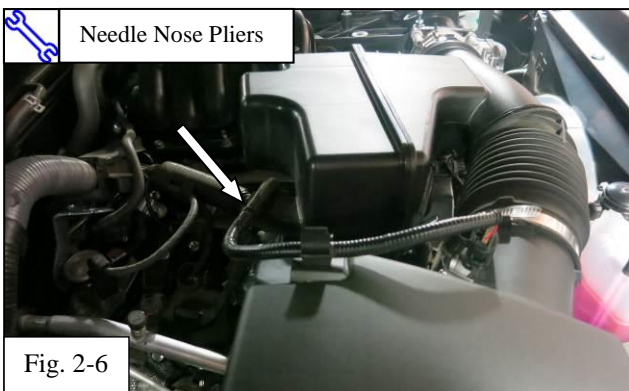

(f) Unclip the MAFS wiring harness from the side of the factory resonance chamber. (Fig. 2-6)

Section 2 – Removal



(g) Unclip the two (2) retaining clips on the air box lid and remove the complete assembly. (Fig. 2-7)

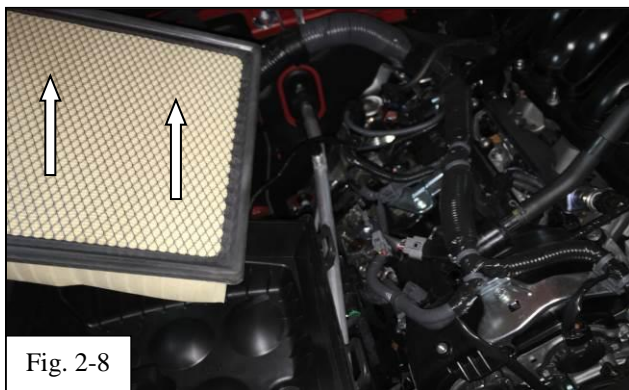

(h) Lift up to remove the factory air filter. (Fig. 2-8)

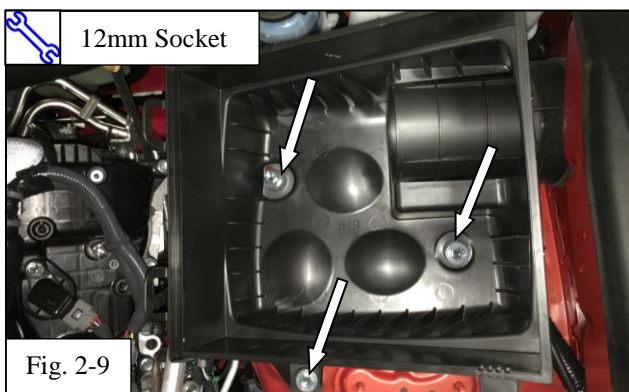

(i) Remove the three (3) M8 bolts holding the lower Airbox and lift out. (Fig. 2-9)

Section 2 – Removal

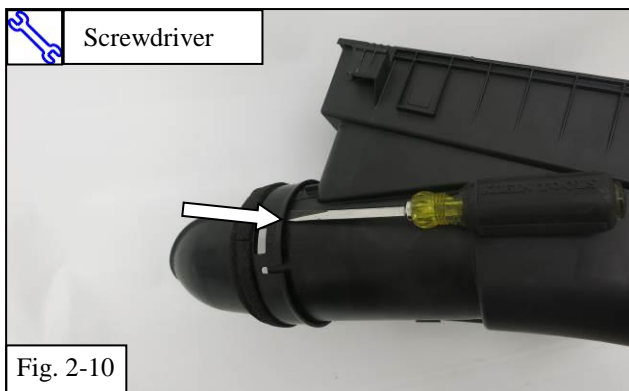

(j) At the workbench, remove the OE air inlet duct from the lower Airbox using a small screw driver or nylon pry tool to raise the area around the locating tab and remove the inlet duct. (Fig. 2-10)

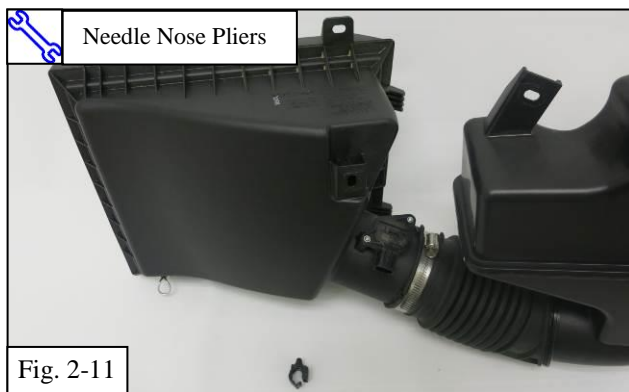

(k) Unclip the MAFS wiring harness clip from the top of the factory airbox lid, retain for later use. (Fig. 2-11)

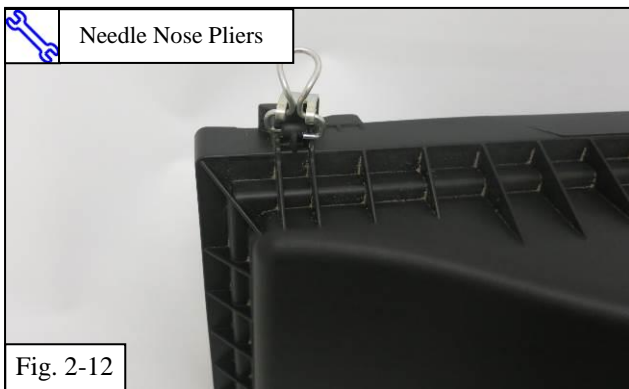

(l) Remove the airbox retaining clips, retain for later use (Fig. 2-12)

Section 2 – Removal

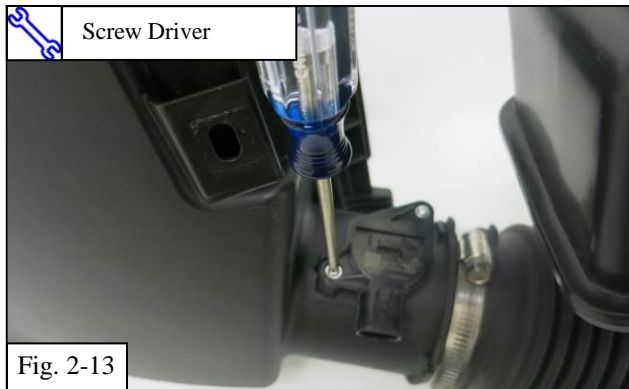

- (m) Undo the MAFS screws and remove the MAFS from the factory airbox lid, retain for later use. (Fig 2-13)

Section 3 – Installation

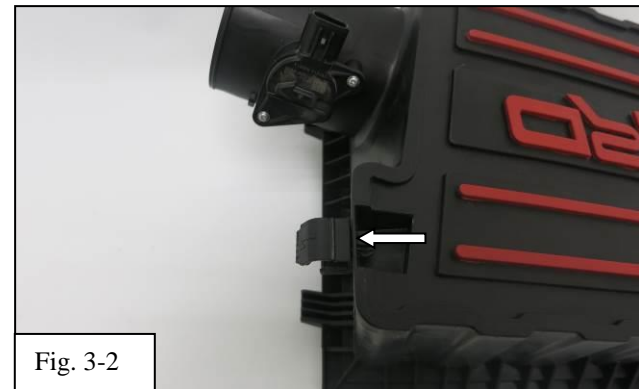
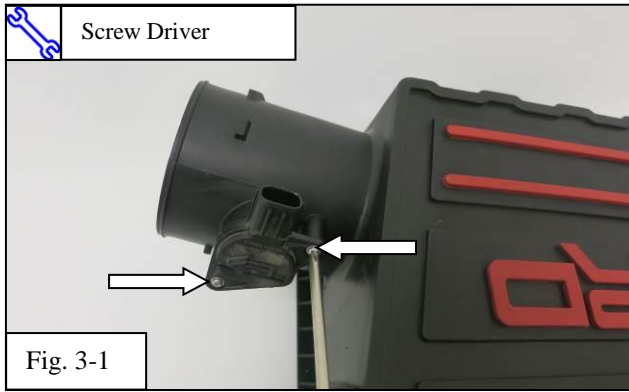

3. Install TRD Air Intake System

(a) At the workbench; install the MAFS into the TRD upper airbox using the screws removed in 2-13. (Fig. 3-1)

(b) Install the MAFS harness clip, removed in 2-11, into the TRD upper airbox. (Fig. 3-2)

(c) Install the airbox retaining clips, removed in 2-12, into the TRD upper airbox. (Fig 3-3)

Section 3 – Installation

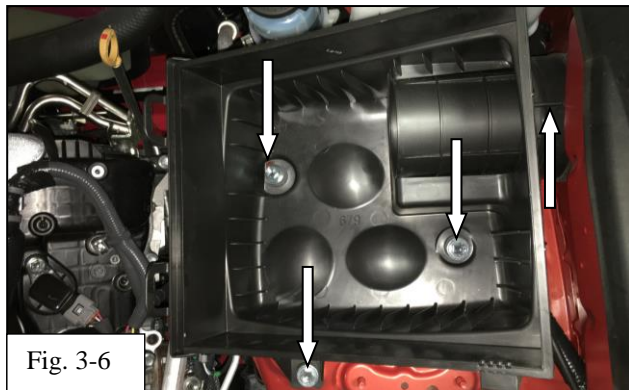
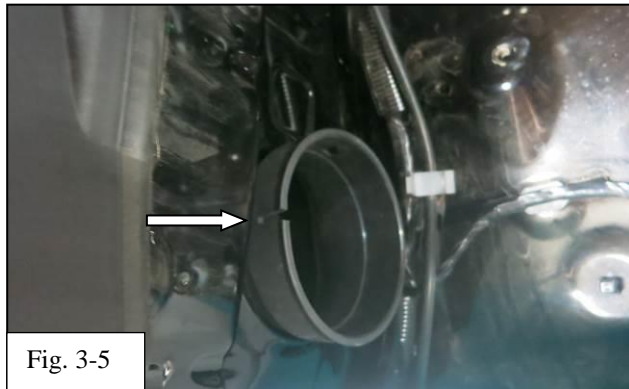
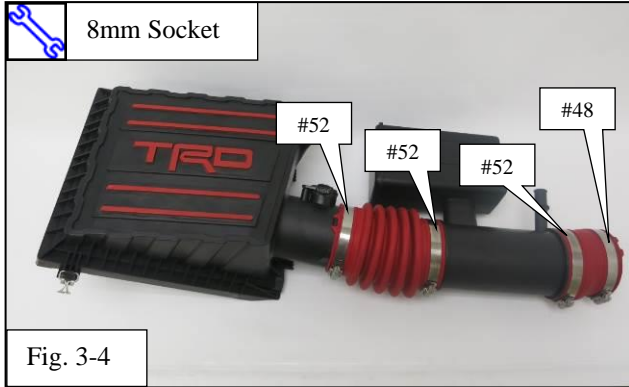

(d) Assemble the Bellows, Inlet Tube and Coupler intake components as shown and attach to the upper airbox. Tighten the #52 hose clamps only. (Fig. 3-4)

(1) Torque to 30in. lb. \pm 5in. lb (3.4Nm \pm .06Nm)

(e) At the vehicle; Install the TRD Air Horn into the inner fender, make sure that the slot is to the top. (Fig.3-5)

(f) Reinstall the lower Airbox housing using the three (3) M8 bolts removed in step 2-i. Make sure to align the tang on the lower airbox with the slot in the air horn. (Fig.3-6)

Section 3 – Installation

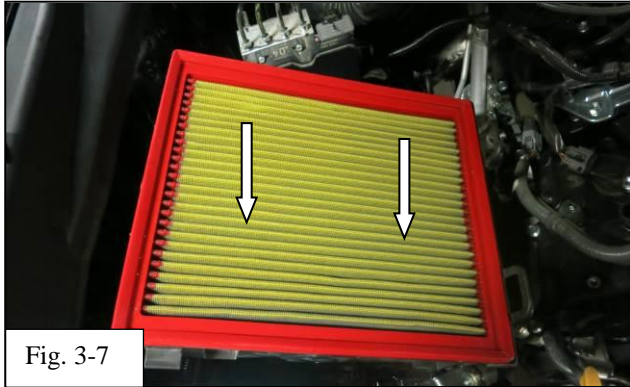

Fig. 3-7

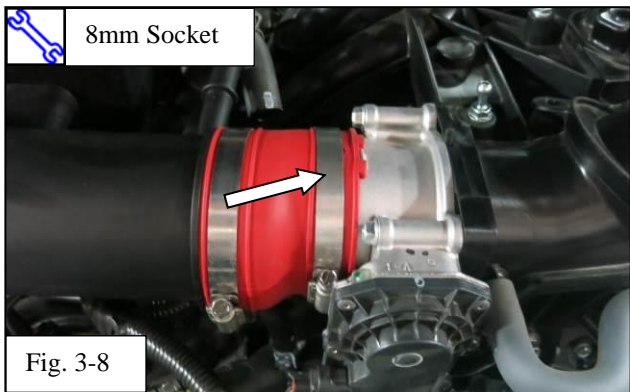



Fig. 3-8



Fig. 3-9

(g) At the vehicle - install the TRD Panel Air Filter in the lower Airbox housing. (Fig.3-7)

(h) Install the assembled TRD Intake system by  pushing the Coupler end over the Throttle body and tighten the #48 hose clamp once positioned. (Fig. 3-8)

(1) Torque to 30in. lb. ± 5in. lb (3.4Nm ±.06Nm)

(i) Make sure the two (2) tabs on the Airbox lid  and Lower housing are fully engaged. (Fig 3-9)

Section 3 – Installation



(j) Engage the clips to secure the Airbox lid
⚠ into place. (Fig. 3-10)

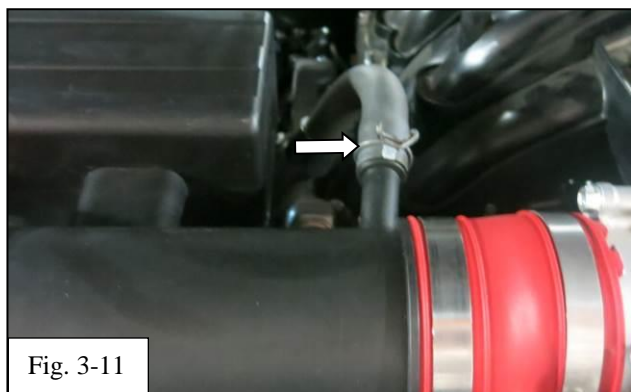

(k) Connect the PCV hose to the Inlet tube
⚠ position the spring clamp over the intake tube nipple. (Fig 3-11)



(l) Attach the MAF wire harness to the side of the TRD resonance chamber. (Fig 3-12)

Section 3 – Installation



(m) Attach the MAF wire harness to the top of the TRD upper airbox. (Fig. 3-13)



(n) Connect the MAF sensor. (Fig. 3-14)

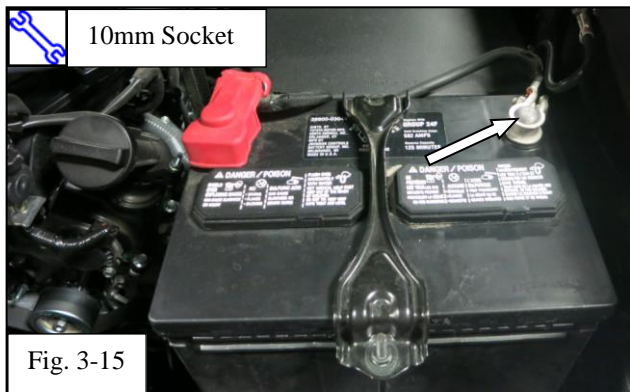

(o) Reconnect the negative battery terminal.

 (Fig. 3-15)

Section 3 – Installation



Fig. 3-16

(p) Reinstall the Engine Cover. (Fig. 3-16)



Fig. 3-17

(q) Apply reusable filter notification label to radiator support cover on passenger side, opposite oil type label. (Fig 3-17)

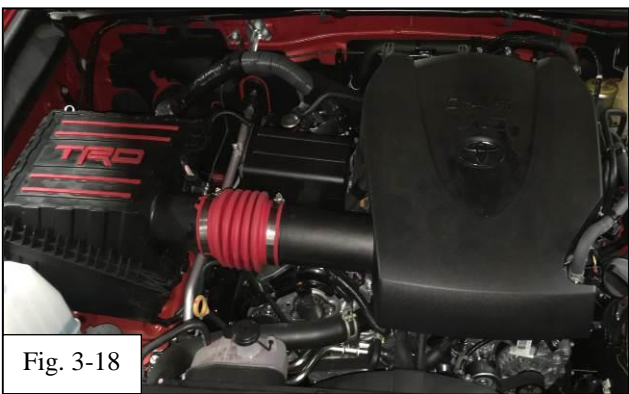

Fig. 3-18

(r) TRD System Installed. (Fig. 3-18)

Section 3 – Installation

1. Caring For the Finish on Your TRD Performance Air Intake

- TRD Performance Air Intake Systems have a natural finish on the couplers and air filter housing.
- To clean your TRD Performance Air Intake system, simply spray with window cleaner and wipe with a soft, clean terry-cloth towel.
- NEVER use harsh chemicals or metal polish on TRD Performance Air Intake systems. Harsh chemicals and metal polishes will permanently damage the finish.
- It is recommended that you service your TRD air filter element with TRD's filter cleaning kit (P/N PTR43-00088) at the TRD recommended service intervals to maintain optimum performance.
- If you live in a region with extremely fine dust (arid or desert climates for example); follow the Toyota recommended service schedule for driving on dirt or dusty roads.

Section 4- Trouble Shooting

Check:	Look For:
<p><u>Accessory Function Checks</u></p> <p><input type="checkbox"/> Start the vehicle.</p> <p><input type="checkbox"/> If after you start the vehicle, or while driving, you encounter a Malfunction Indicator Lamp (MIL), check the following.</p>	<ul style="list-style-type: none"> ○ Smooth idle and no MIL. ○ Full engagement of MAF sensor connector. ○ Tightness of all clamps. ○ Correctly installed valve cover breather hose.
<p><u>Vehicle Function Checks</u></p> <p><input type="checkbox"/> Start the vehicle</p> <p><input type="checkbox"/> If the lamp will not go off even after checking and/or repairing any of the above.</p>	<ul style="list-style-type: none"> ○ Smooth idle and no MIL. ○ Contact your Toyota dealer as soon as possible.